

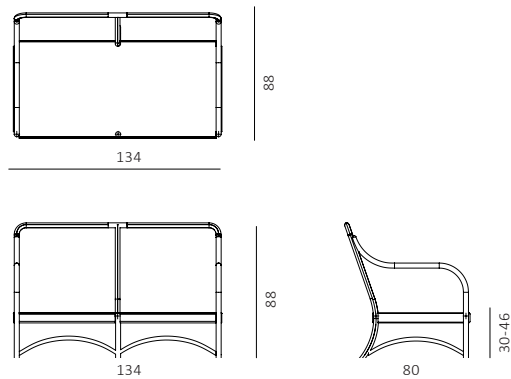

Item code: **OLDI2WP**



## TERMS OF USE



Hard Conditions: bar, pub



Seaside



Medium Conditions: HORECA

## MATERIALS AND FINISHES

Aluminium frame with WaProLace cover



Natural



White

## TYPE OF PRODUCT

Assembled

## PACKAGING

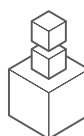

1 pz



29 Kg

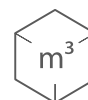

1,056 m<sup>3</sup>



138 x 85 x 90 cm



Item code: **OLDI3WP**

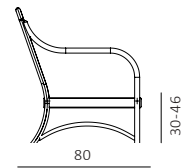
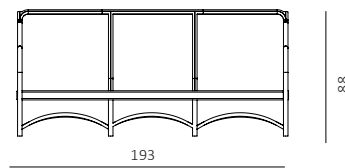
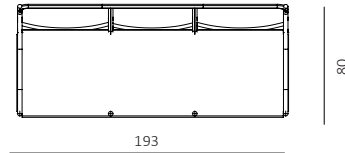

### TERMS OF USE

**H** Hard Conditions: bar, pub

**SG** Seaside

**M** Medium Conditions: HORECA

### MATERIALS AND FINISHES

Aluminium frame with WaProLace cover



Natural



White

### TYPE OF PRODUCT

Assembled

### PACKAGING

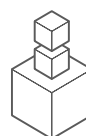

1 pz



48 Kg

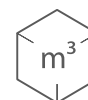

1,507 m<sup>3</sup>



197 x 85 x 90 cm

Item code: **OLPOLW**

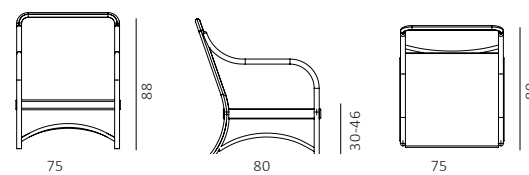

## TERMS OF USE

**H**

Hard Conditions: bar, pub

**SG**

Seaside

**M**

Medium Conditions: HORECA

## MATERIALS AND FINISHES

Aluminium frame with WaProLace cover



Natural



White

## TYPE OF PRODUCT

Assembled

## PACKAGING

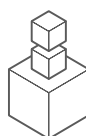

1 pz



20 Kg

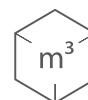

0,604 m<sup>3</sup>



79 x 85 x 90 cm

**CURA E MANUTENZIONE****ALLUMINIO**

Per mantenere pulito l'alluminio è sufficiente una bacinella con acqua pulita tiepida, un detergente solido o liquido neutro – non abrasivo e non a base di ammoniaca, candeggina o alcool – panni morbidi e una spugna non abrasiva. Utilizzare il panno morbido per asciugare ed evitare la formazione di aloni. Si raccomanda di utilizzare solo acqua tiepida a temperatura massima di 30°. Nel caso di macchie persistenti utilizzare una soluzione di aceto, sapone di Marsiglia neutro o bicarbonato (un cucchiaino di sapone/bicarbonato per ogni litro di acqua).

**WAPROLACE**

Per mantenere pulita la fibra sintetica WaProLace® Unopiù ha messo a punto un kit di pulizia ad hoc. Il kit è composto da un detergente speciale non schiumogeno che rimuove lo sporco e ripristina l'aspetto della fibra e uno spray di protezione che alimenta i plastificanti e mantiene la flessibilità della fibra. Il filtro UV ne mantiene inoltre l'aspetto e prolunga la durata nel tempo aiutando a prevenire le macchie.

**CARE AND MAINTENANCE****ALUMINUM**

To maintain the aluminium clean use a basin with warm clean water, a solid or neutral liquid detergent (non-abrasive and not ammonia, bleach or alcohol-based) soft cloths and a non-abrasive sponge. Use a soft cloth to prevent halos. It is recommended to use only lukewarm water (maximum 30°C). In case of persistent stains use a solution of vinegar, neutral Marseille soap or bicarbonate (a spoonful of soap/bicarbonate for each liter of water).

**WAPROLACE**

To keep the synthetic fiber clean WaProLace® Unopiù has developed a specific kit. The kit is made of a special non-foaming detergent that removes dirt and restores the fiber and a protective spray that revives the plasticizers and maintains the fiber's flexibility. The UV filter helps the fiber maintain its appearance and extends its duration over time, protecting it from stains.